

SMART  
OFFICE

**MORE**  
IL TAVOLO  
ECLETTICO **THE**  
**ECLECTIC TABLE**

---

05





NELLE INFINITE COMBINAZIONI CHE PUÒ ASSUMERE, MORE RIVELA L'EQUILIBRATA ELEGANZA SENZA TEMPO DI UNA FAMIGLIA DI TAVOLI CHE PUÒ DECLINARSI TANTO IN TAVOLINO QUANTO IN TAVOLO DA PRANZO, PIUTTOSTO CHE SCRIVANIA DA UFFICIO O TAVOLO DA CONFERENZA.

IN THE ENDLESS COMBINATIONS THAT IT CAN ASSUME, MORE BY ESTEL REVEALS THE BALANCE OF TIMELESS ELEGANCE IN A FAMILY OF TABLES THAT CAN EVOLVE INTO END TABLES OR INTO TABLES FOR DINING OR CONFERENCES.





TAVOLO RETTANGOLARE  
RECTANGULAR TABLE

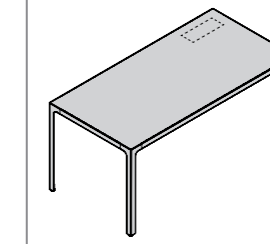

TAVOLO QUADRATO  
SQUARED TABLE

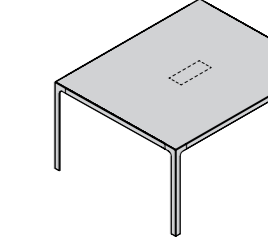

BENCH 4 POSTI  
4 PLACES BENCH

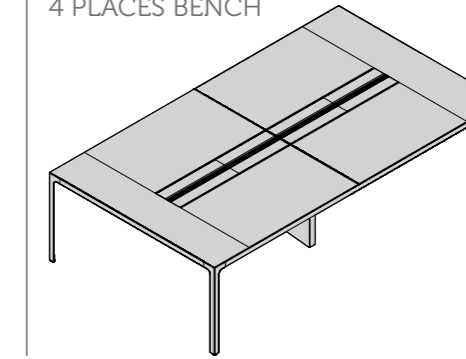

SCRIVANIA QUADRATA CON MOBILE DI SERVIZIO  
SQUARED DESK WITH SERVICE UNIT

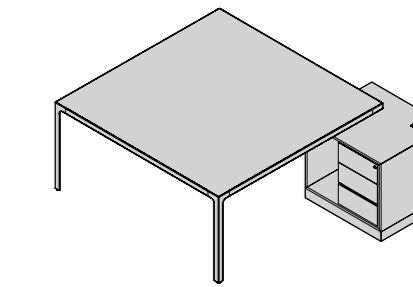

TAVOLO RIUNIONE  
MEETING TABLE

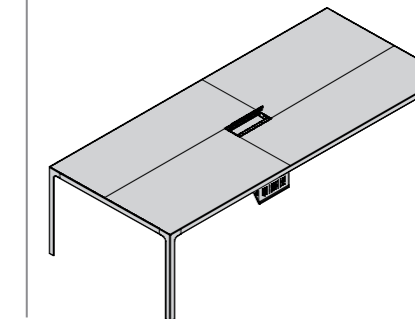

TAVOLO MINI RIUNIONE  
CONFERENCE-MEETING TABLE

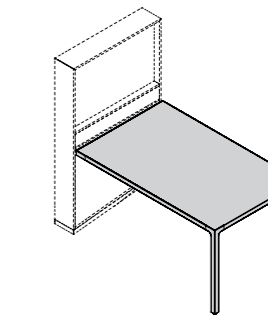

RECEPTION  
RECEPTION

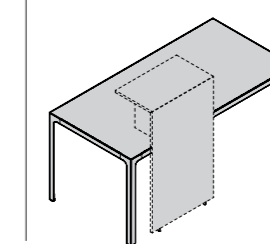

BANCONCINO  
HIGH TABLE

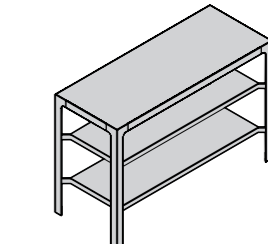

TAVOLINO  
COFFEE TABLE

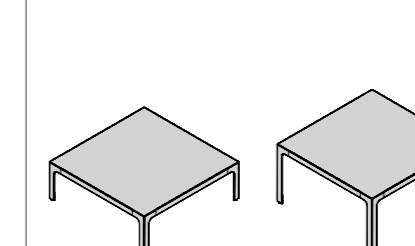

MORE

MORE

UN TAVOLO CHE SI DECLINA IN UN SISTEMA. UN TAVOLO CHE SI ADATTA AD UN USO TRASVERSALE, CHE DIALOGA CON QUALSIASI AMBIENTE, DALLA SALA DA PRANZO AL SALOTTO, ALLA CAMERA DA LETTO, DALLA SCRIVANIA DOMESTICA O DA UFFICIO, ALLA SALA RIUNIONI O DIRIGENZIALE. LA SUA STRUTTURA PERMETTE DI CREARE COMPLEMENTI DALLO STILE ALTAMENTE PERSONALIZZABILE E FLESSIBILE. L'ELEMENTO DISTINTIVO È RAPPRESENTATO DALLA STRUTTURA DI SUPPORTO, COMPOSTA DA GAMBE IN METALLO CHE SI INNESTANO NEI PROFILI ORIZZONTALI CON UN'ARCATA FLUIDA E MISURATA. I PIANI, INCORNICIATI A FILO DAL TELAIO PORTANTE, SONO DISPONIBILI IN DIVERSE FINITURE, IN LAMINATO, IN LACCATO, IN VETRO RETROLACCATO, IN VETRO TRASPARENTE, IN CUIO O IN VARIE ESSENZE MASSELLO, COME LA STRUTTURA PORTANTE, DISPONIBILE IN VARIE FINITURE A CATALOGO. MODIFICANDO LE SUE MISURE IN LARGHEZZA, PROFONDITÀ E ALTEZZA, COMBINANDO LE SUPERFICI AI MOLTI MATERIALI E FINITURE DISPONIBILI, IL TAVOLO MORE RESTITUISCE UN'IMMAGINE DI GRANDE PERSONALITÀ E CARATTERE, SEPPURE NELLA SUA ESSENZIALE, ICONICA SEMPLICITÀ.

MORE: A TABLE THAT IS TRANSFORMED INTO A SYSTEM, THAT ADAPTS TO TRANSVERSAL USE, INTERFACING WITH ANY ENVIRONMENT, FROM THE DINING ROOM TO THE LIVING ROOM, TO THE BEDROOM, FROM THE HOME DESK TO THE OFFICE DESK, FROM MEETING ROOMS TO THE EXECUTIVE OFFICES. ITS STRUCTURE ALLOWS YOU TO CREATE EXTREMELY CUSTOMIZED AND FLEXIBLE ACCESSORIES. THE DISTINCTIVE ELEMENT IS REPRESENTED BY THE SUPPORT STRUCTURE, CONSISTING OF METAL LEGS THAT ARE INSERTED INTO THE HORIZONTAL PROFILES WITH A FLUID AND MEASURED ARCH. THE TOPS ARE SURROUNDED BY A FLUSH FIT METAL FRAME, AVAILABLE IN DIFFERENT FINISHES, MELAMINE, LACQUERED, BACK-PAINTED GLASS, WOOD OR LEATHER; THE SAME VARIETY APPLIES TO THE SUPPORTING STRUCTURE, AVAILABLE IN THE MANY CATALOG FINISH OPTIONS. BY CHANGING ITS DIMENSION IN WIDTH, LENGTH OR HEIGHT, BY COMBINING TOPS WITH THE MANY AVAILABLE MATERIALS AND FINISHES, MORE TABLE IS THE IMAGE OF GREAT PERSONALITY AND CHARACTER, EVEN IN ITS ESSENTIAL, ICONIC SIMPLICITY.

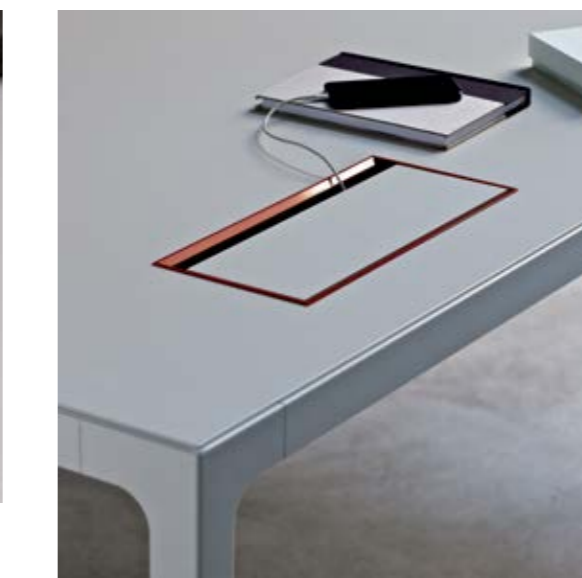
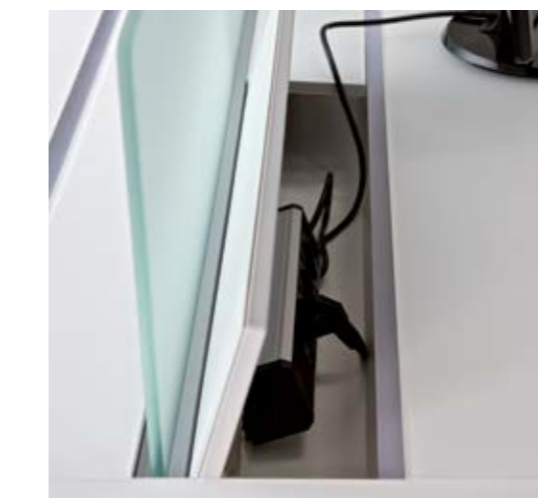



---

**ESTEL**  
— OFFICE LIVING —