

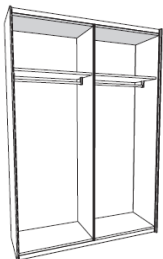

Aesthetic characteristics: wardrobe

STRUCTURE CHARACTERISTICS



TOPS

*Thickness: 2.5 cm
Finishes: Delavé Texture, Comfort Texture, Dark Oak Decor, Bianco Neve Lacquered*

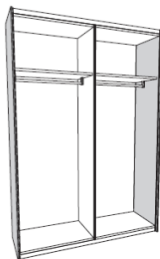

END PANELS

*Thickness: 2.5 cm
Consisting of one internal panel 1.2 cm thick in finish Delavé Texture, Comfort Texture, Dark Oak Decor, Bianco Neve Lacquered, joined together with one external panel 1.2 cm thick in finish Delavé Texture, Comfort Texture, Dark Oak Decor, Magnolia Decor, Olmo Perla Decor, Lacquered, Glossy lacquered, Thermo treated Oak Veneer, natural olive or open pore glossy lacquered Ash Veneer*

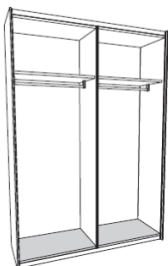

BOTTOMS

*Thickness: 2.5 cm
Finishes: Delavé Texture, Comfort Texture, Dark Oak Decor, Bianco Neve Lacquered*

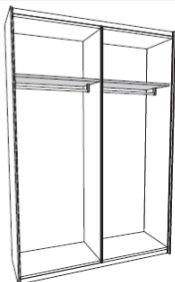

SHELVES

*Thickness: wooden shelf 2.5 cm, wooden shelf 3.8 cm, glass shelf 0.8 cm
Finishes: Delavé Texture, Comfort Texture, Dark Oak Decor, Bianco Neve Lacquered, tempered clear Glass*

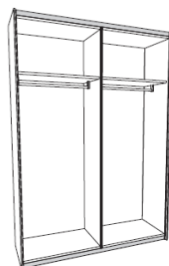

SKIRTING FRONTS FOR WARDROBES WITH WING DOORS

*Finishes: Comfort anodized
Special gaskets in soft coextruded material are mounted in order to assure an excellent closing of the wardrobe*

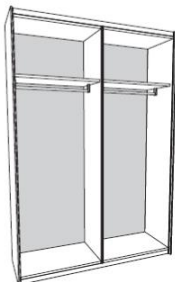

BACKS

*Thickness: 1.2 cm
Finishes: Delavé Texture, Comfort Texture, Dark Oak Decor, Bianco Neve Lacquered*

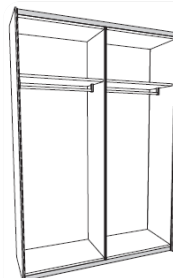

RAILS FOR WARDROBES WITH SLIDING OR FLUSH-FIT DOORS

Finishes: Silver anodized with carter in Comfort finish

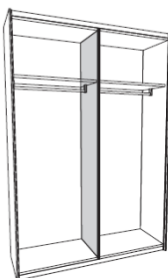

INTERMEDIATE SIDE PANELS

*Thickness: 2.5 cm Finishes: Delavé Texture, Comfort Texture, Dark Oak Decor, Bianco Neve Lacquered.
Special gaskets in soft coextruded material assure a closing of the (wing doors) wardrobe.*

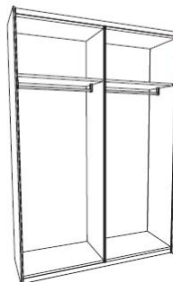

CLOTHES RODS

Finishes: Comfort anodized

Aesthetic characteristics: wardrobe

MODULARITY

The total size of the wardrobe is obtained by adding the sizes of the compartments and then adding an extra 2.5 cm for the end or intermediate panel.

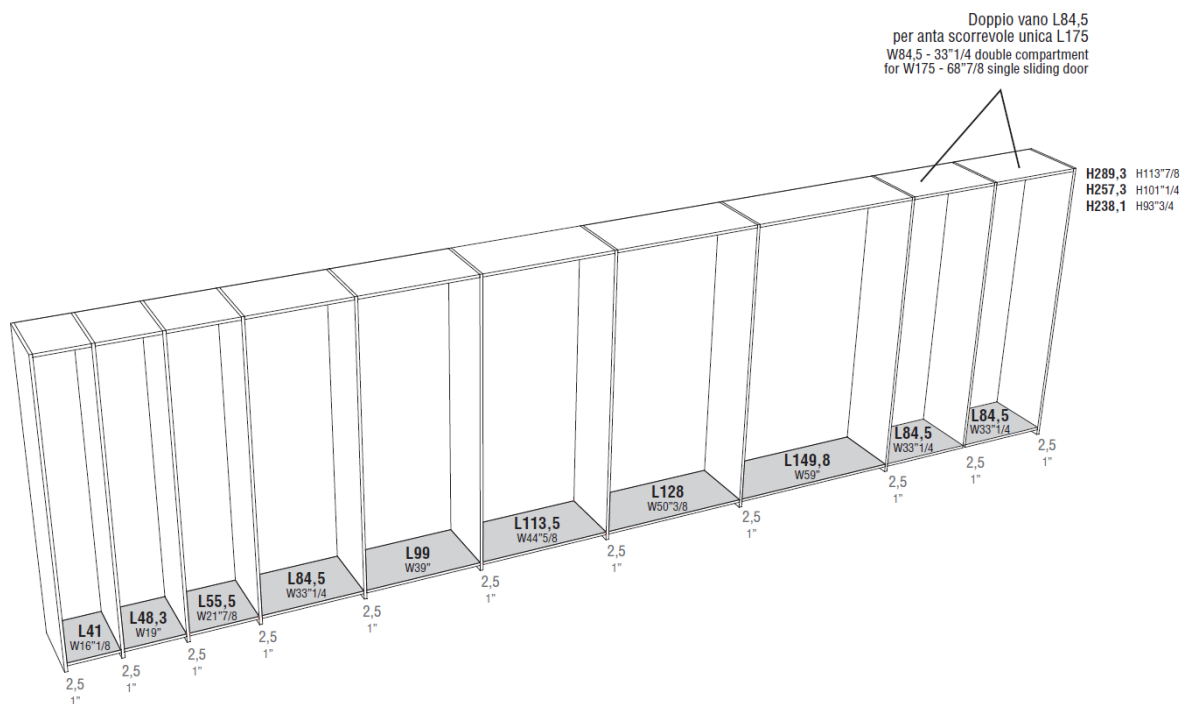

WARDROBES DEPTH (except handles)

WING DOOR

From D61.7 to D62.7

SLIDING DOOR

From D65.5 to D69.6

FLUSH-FIT DOOR

From D61.7 to D63.8

INCLUDED IN PRICE

D55 cm and 2.5 cm thick shelf, and two clothes hanger rails for each compartment and one clothes hanger pole for each wardrobe.

Aesthetic characteristics: doors

ANTEPRIMA - wing, sliding and flush-fit doors



Door composed by a wood panel 22 mm thick, in melamine, edged on four sides.

DOOR FINISH

Delavé Texture, Comfort Texture, Dark Oak Decor, Magnolia Decor, Olmo Perla Decor, Lacquered, Glossy lacquered, Thermo treated Oak Veneer *, natural olive or open pore glossy lacquered Ash veneer *

* Thermo treated Oak and natural olive or open pore glossy lacquered Ash veneer have vertical vein direction.

door section



Aesthetic characteristics: doors

Bianco - wing and sliding doors



Door composed by a panel in MDF 25 mm thick with concealed handle.

DOOR FINISH

Lacquered in available colours

Bianco door can be equipped with a LED in the channel handle for an easy identification in the darkness.

door section

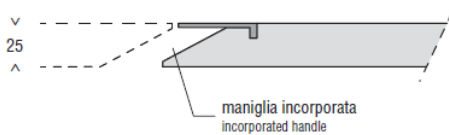

Aesthetic characteristics: doors

ANFITEATRO - sliding doors



Door composed by an aluminium frame, 40 mm thick, with 2 wood panels in melamine 22 mm thick. Double glazed door, composed by an aluminium frame, 40 mm thick, to which two tempered glasses or two security mirrors are fixed to.

DOOR FINISH

Lacquered, Glass/ Mirror

FRAME FINISH

Polished Aluminium, Comfort anodized Aluminium, White varnished

sezione anta scorrevole
sliding door section



sezione anta vetro scorrevole
glazed sliding door section

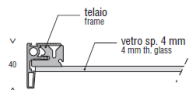

RIGUARDAROBA

Aesthetic characteristics: doors

QUERINI - wing, sliding and flush-fit doors



Door composed by a wood panel with rounded 22 mm thick for wing door and by a hollow panel 45 mm thick for sliding and flush-fit door, in melamine, edged on four sides and lacquered.

DOOR FINISH

Lacquered in available colours

sezione anta battente
wing door section

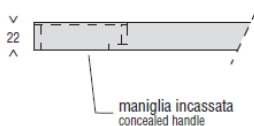

sezione anta scorrevole/ anta complanare
sliding door/ flush-fit door section

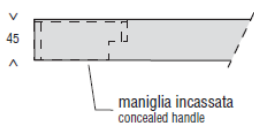

Aesthetic characteristics: doors

PALEA - wing, sliding and flush-fit doors

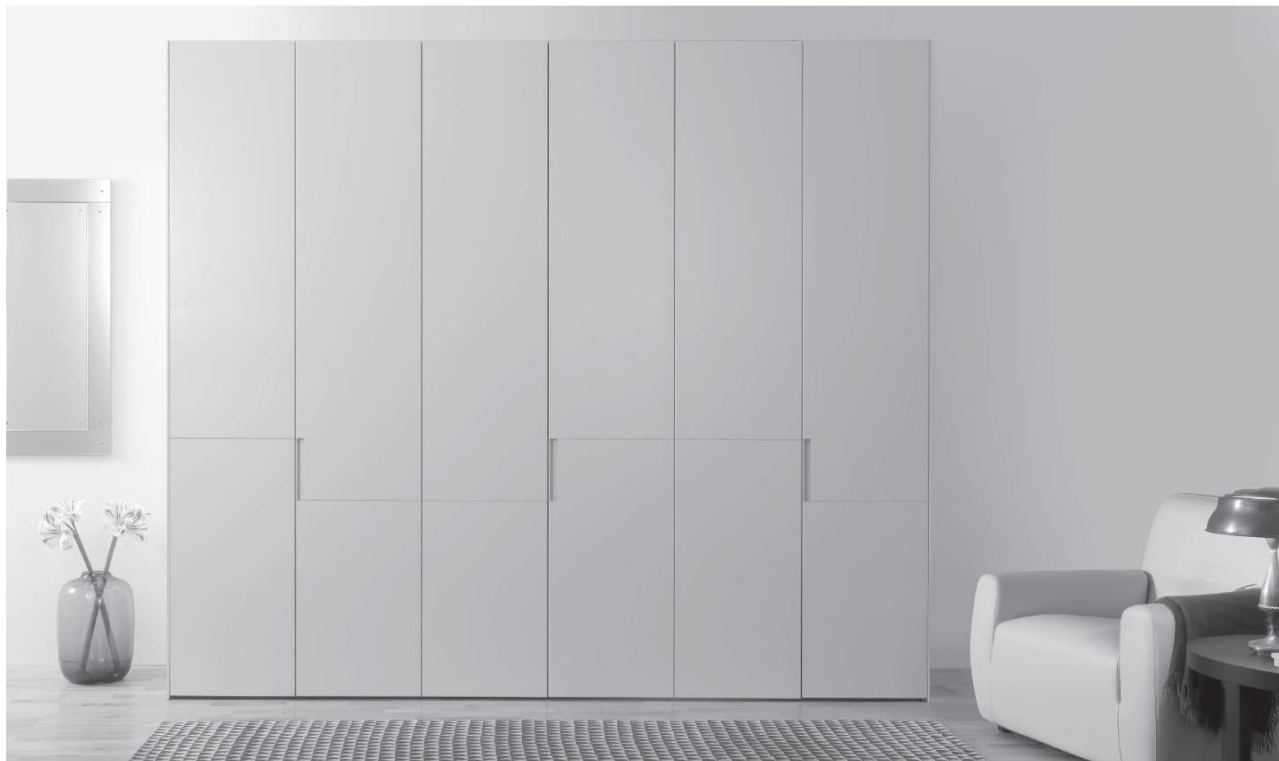

Door composed by a panel in MDF 25 mm thick for wing and sliding door and by a hollow panel for flush-fit door, 45 mm thick, edged on four sides.

DOOR FINISH

Lacquered in available colours

sezione anta
door section

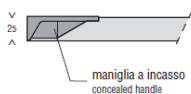

sezione anta complanare
flush-fit door section

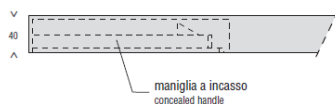

Aesthetic characteristics: doors

PALCO - wing and sliding doors



Door composed by a panel in MDF 25 mm thick edged on four sides and lacquered.

DOOR FINISH

Lacquered in available colours

sezione anta (ad altezza maniglia)
door section (at handle height)

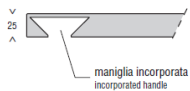

Caratteristiche estetiche: ante

SKETCH - wing and sliding doors



Door composed by a panel in MDF 25 mm thick with concealed handle, characterised by vertical engravings.

DOOR FINISH

Heat-treated Oak Veneer *, natural olive or open pore glossy lacquered Ash veneer *

Sketch door can be equipped with a LED in the channel handle for an easy identification in the darkness.

Thermo treated Oak and natural olive or open pore glossy lacquered Ash veneer have vertical vein direction.

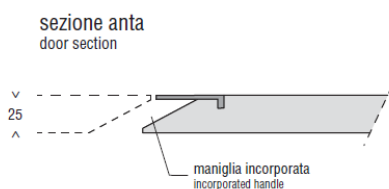

Caratteristiche estetiche: ante**STEP - wing doors**

Door composed by a wood panel 22 mm thick, in melamine, edged on four sides.

DOOR FINISH

Delavé Texture, Comfort Texture, Dark Oak Decor, Magnolia Decor, Olmo Perla Decor, Lacquered

DRAWERS FINISH

Delavé Texture, Comfort Texture, Dark Oak Decor, Magnolia Decor, Olmo Perla Decor, Lacquered, Thermo treated Oak Veneer, natural olive or open pore glossy lacquered Ash, Canaletto Walnut, Barrique Oak Veneer



Caratteristiche estetiche: ante

INCORPORATED HANDLES

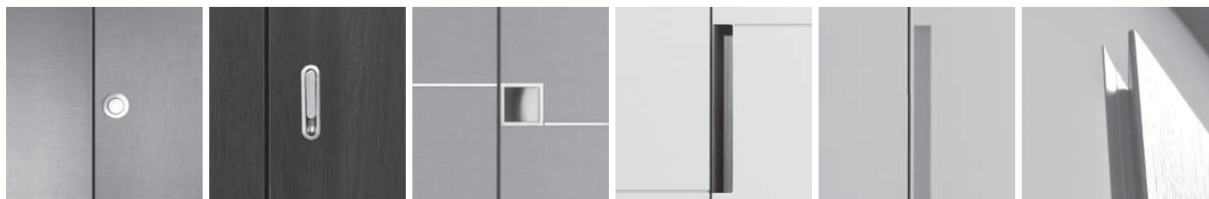

	PREMI - APRI <i>PUSH - PULL</i>	INCASSO <i>INCASSO</i>	QUERINI <i>QUERINI</i>	PALEA <i>PALEA</i>	PALCO <i>PALCO</i>	SKECTH - BIANCO * <i>SKECTH - BIANCO *</i>
Finitura Finish	CROMO LUCIDO GLOSSY CHROMED	CROMO LUCIDO ALL. ANODIZZATO COMFORT GLOSSY CHROMED COMFORT ANODIZED ALUMINIUM	DORATA, CROMATA, COMFORT GOLDEN, CHROMED, COMFORT	INSERTO IN LEGNO MASSELLO DI NOCE RIGATO SOLID WOOD INSERT IN STRIPED WALNUT	STESSA FINITURA DELL'ANTA SAME FINISH AS THE DOOR	STESSA FINITURA DELL'ANTA SAME FINISH AS THE DOOR
Dimensioni Dimension	Ø 3 cm P 2,2 cm Ø 3 cm D 2,2 cm	H 7,4 cm H 7.4 cm	H 6 - H 8 cm L 6 - L 8 cm H 6 - H 8 cm W 6 - W 8 cm	H 24,4 cm L 3,2 cm H 24.4 cm W 3.2 cm	H 108 cm L 3,2 cm H 108 cm W 3.2 cm	H ANTA H DOOR
Di serie Standard	ANTEPRIMA BATTENTE STEP BATTENTE ANTEPRIMA WITH WING DOORS STEP WITH WING DOORS	ANTEPRIMA SCORREVOLE E COMPLANARE ANTEPRIMA WITH SLIDING AND FLUSH-FIT DOORS	QUERINI QUERINI	PALEA PALEA	PALCO PALCO	SKETCH - BIANCO SKETCH - BIANCO
Disponibile senza sovrapprezzo Optional without upcharge	ANTEPRIMA SCORREVOLE (SOLO ARMADI 2 ANTE) ANTEPRIMA WITH SLIDING DOORS (ONLY 2 DOORS WARDROBES)	ANTEPRIMA BATTENTE ANTEPRIMA WITH WING DOORS				

Bianco door and Sketch doors can be equipped with a LED in the channel handle for an easy identification in the darkness.

EXTERNAL HANDLES

HINGES

Available hinges with 165° opening



	TRACCIA <i>TRACCIA</i>	LINEA <i>LINEA</i>
Finitura Finish	CROMO LUCIDO/ BIANCO ALL. ANODIZZATO COMFORT GLOSSY CHROMED/ WHITE COMFORT ANODIZED ALUMINIUM	ALLUMINIO ANODIZZATO ANODIZED ALUMINIUM
Dimensioni Dimension	H 12 cm H 12 cm	H 18,5 - H 96 cm L 1,6 cm - P 3,9 cm H 18,5 - H 96 cm W 1.6 cm - D 3.9 cm
Di serie Standard	ANFITEATRO BATTENTE ANFITEATRO WITH WING DOORS	
Disponibile senza sovrapprezzo Optional without upcharge	ANTEPRIMA BATTENTE ANTEPRIMA WITH WING DOORS	ANTEPRIMA BATTENTE E SCORREVOLE ANTEPRIMA WITH WING AND SLIDING DOORS

How to use the “Modular Planning”

The modular planning was studied to meet all the requests that cannot be satisfied using the pricelists elements. The modular planning was organized according to a logical of composition construction that starts from the choice of the modules and doors of the wardrobes, adding then the sides and ends with the terminal sides.

In order to prepare a correct quotation it is necessary to send the plan drawing and the view, specifying also:

1. Code, finish and height of each single module with specification of the side of the doors, rt or lt, internal or external (if sliding)
2. Item code, finish and height of the intermediate side
3. Code and finish for the terminal sides

The price of the wardrobe is made adding the prices of point 1 - 2 - 3.

MODULARITY RULES

1. It is possible to prepare mixed wardrobes with wing or sliding doors. The sliding one contiguous to the hinged module must be sliding internally.

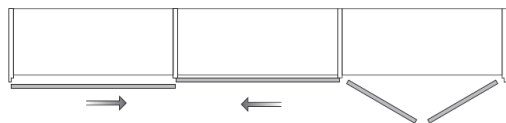

All the compositions, must be checked by the technical department in advance, before accepting the order.

Wardrobes with wing doors - WIDTHS

fino a L100 up to W100	L46 - W18"	41
	L53,3 - W20"3/4	48,3
	L60,5 - W23"1/2	55,5
	L89,5 - W35"	84,5
	L96,8 - W37"3/4	41 48,3
da L100 a L200 from W100 to W200	L104 - W40"1/2	99
	L104 - W40"1/2	41 55,5
	L111,3 - W43"1/2	55,5 48,3
	L118,5 - W46"1/4	113,5
	L134 - W52"1/4	84,5 41
	L140,3 - W54"3/4	84,5 48,3
	L140,3 - W54"3/4	48,3 41 41
	L147,5 - W57"1/2	41 99
	L154,8 - W60"1/4	99 48,3
	L154,8 - W60"1/4	55,5 41 48,3
	L162 - W63"1/4	99 55,5
	L169,3 - W66"	113,5 48,3
	L176,5 - W68"3/4	84,5 84,5
	L176,5 - W68"3/4	55,5 113,5
	L176,5 - W68"3/4	41 84,5 41
	L183,8 - W71"3/4	84,5 41 48,3
	L191 - W74"1/2	99 84,5
	L191 - W74"1/2	41 99 41
	L191,1 - W74"1/2	48,3 84,5 48,3
	da L200 a L270 from W200 to W270	L205,5 - W80"1/4
L205,5 - W80"1/4		48,3 99 48,3
L205,5 - W80"1/4		99 41 55,5
L205,5 - W80"1/4		84,5 113,5
L205,5 - W80"1/4		41 113,5 41
L205,5 - W80"1/4		55,5 84,5 55,5
L220 - W85"3/4		84,5 41 84,5
L220 - W85"3/4		99 113,5
L220 - W85"3/4		55,5 99 55,5
L220,1 - W85"3/4		48,3 113,5 48,3
L234,5 - W91"1/2		113,5 113,5
L234,5 - W91"1/2		99 41 84,5
L234,5 - W91"1/2		55,5 113,5 55,5
L234,6 - W91"1/2		48,3 84,5 41 48,3
L249 - W97"		55,5 84,5 41 55,5
L249 - W97"		99 41 99
L256,3 - W100"		113,5 48,3 84,5
L256,6 - W100"		99 48,3 99
L263,5 - W102"3/4		99 55,5 99
L263,5 - W102"3/4		84,5 84,5 84,5
L263,5 - W102"3/4	41 84,5 84,5 41	
L270,8 - W105"1/2	113,5 48,3 99	
L270,8 - W105"1/2	55,5 99 48,3 55,5	

da L270 a L300 from W270 to W300	L278 - W108"1/2	84,5 99 84,5
	L278 - W108"1/2	99 55,5 113,5
	L278,1 - W108"1/2	48,3 84,5 84,5 48,3
	L285,3 - W111"1/4	113,5 48,3 113,5
	L292,5 - W114"	99 84,5 99
	L292,5 - W114"	113,5 55,5 113,5
	L292,5 - W114"	41 99 99 41
	L292,5 - W114"	55,5 84,5 84,5 55,5
	L292,5 - W114"	84,5 113,5 84,5
	L292,6 - W114"	48,3 99 84,5 48,3
da L300 a L400 from W300 to W400	L307 - W119"3/4	99 99 99
	L307 - W119"3/4	41 84,5 41 84,5 41
	L307 - W119"3/4	84,5 84,5 84,5 41
	L307 - W119"3/4	113,5 84,5 99
	L307,1 - W119"3/4	48,3 99 99 48,3
	L314,3 - W122"1/2	41 84,5 48,3 84,5 41
	L321,5 - W125"1/2	99 113,5 99
	L321,5 - W125"1/2	41 113,5 113,5 41
	L321,6 - W125"1/2	84,5 48,3 41 48,3 84,5
	L328,8 - W128"1/4	84,5 99 48,3 84,5
	L328,9 - W128"1/4	48,3 84,5 48,3 84,5 48,3
	L336 - W131"	99 41 84,5 99
	L336 - W131"	113,5 99 113,5
	L343,3 - W134"	41 99 48,3 99 41
	L343,3 - W134"	48,3 99 99 84,5
	L350,5 - W136"3/4	84,5 84,5 84,5 84,5
	L350,5 - W136"3/4	113,5 113,5 113,5
	L350,5 - W136"3/4	41 84,5 84,5 84,5 41
	L350,5 - W136"3/4	84,5 113,5 55,5 84,5
	L350,5 - W136"3/4	99 99 99 41
L357,8 - W139"1/2	48,3 99 99 99	
L357,9 - W139"1/2	48,3 99 48,3 99 48,3	
L365 - W142"1/4	41 84,5 99 84,5 41	
L365 - W142"1/4	41 113,5 41 113,5 41	
L365,1 - W142"1/4	48,3 84,5 84,5 84,5 48,3	
L379,5 - W148"	84,5 99 99 84,5	
L379,5 - W148"	41 99 84,5 99 41	
L379,5 - W148"	99 113,5 55,5 99	
L379,5 - W148"	41 99 99 99 41	
L394 - W153"3/4	41 84,5 84,5 84,5 84,5	
L394,1 - W153"3/4	48,3 99 84,5 99 48,3	
oltre L400 more than W400	L401,3 - W156"1/2	84,5 84,5 48,3 84,5 84,5
	L408,5 - W159"1/4	99 99 99 99
	L408,6 - W159"1/4	48,3 99 99 99 48,3

In bold type the widths of proposed wardrobes. The others are obtained with modular planning.

Wardrobes with sliding doors - WIDTHS

fino a L200 up to W200	L176,5 - W68"3/4	84,5	84,5		
	L191 - W74"1/2	99	84,5		
da L200 a L300 from W200 to W300	L205,5 - W80"1/4	99	99		
	L220 - W86"5/8	99	113,5		
	L234,5 - W91"1/2	113,5	113,5		
	L249 - W98"	113,5	128		
	L263,5 - W102"3/4	128	128		
	L263,5 - W102"3/4	84,5	84,5	84,5	
	L278 - W108"1/2	84,5	99	84,5	
	L292,5 - W114"	99	84,5	99	
	da L300 a L400 from W300 to W400	L307 - W119"3/4	99	99	99
		L307,1 - W119"3/4	149,8	149,8	
L350,5 - W136"3/4		84,5	84,5	84,5	84,5
L350,5 - W136"3/4		113,5	113,5	113,5	
L365 - W143"3/4		113,5	128	113,5	
L379,5 - W149"3/8		128	113,5	128	
L379,5 - W149"3/8		84,5	99	99	84,5
L394 - W153"3/4		128	128	128	
L408,5 - W159"1/4	99	99	99	99	

Wardrobes with flush-fit doors- WIDTHS

fino a L300 up to W300	L176,5 - W68"3/4	84,5	84,5		
	L205,5 - W80"1/4	99	99		
oltre L300 more than W300	L234,5 - W91"1/2	113,5	113,5		
	L263,5 - W102"3/4	128	128		
oltre L300 more than W300	L307,1 - W119"3/4	149,8	149,8		
	L350,5 - W136"3/4	84,5	84,5	84,5	84,5
	L408,5 - W159"1/4	99	99	99	99

In bold type the widths of proposed wardrobes. The others are obtained with modular planning.

Special elements

TRAPEZIO

TRAPEZIO

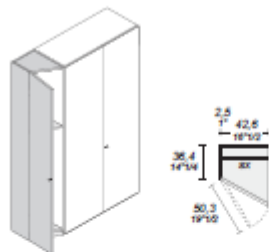

DESCRIZIONE

Elemento terminale di una composizione che permette di ridurre la profondità in prossimità delle estremità.

MISURE/ INGOMBRI

Ha una luce interna di 42,6 cm. Nel caso di accostamento l'ingombro è di 45,1 cm (pari alla luce interna + 1 fi anco).

H 239/258/290 cm; P 36,4 cm; L 45,1 cm.

TRAPEZIO LARGE

TRAPEZIO LARGE

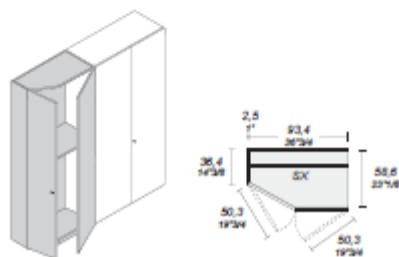

DESCRIPTION

An alternative to the traditional triangular element which allows more space in the shaped unit.

SIZES/ VOLUMES

The internal usable width is 93.4 cm. In case of combination the total usable width is 95.9 cm (equivalent to the usable width + 1 side).

H 239/258/290 cm; D 36.4 cm; W 95.9 cm.

INTERNAL EQUIPMENT

A shaped shelf and 2 clothes hanger rail.

ANGOLO A L

L-CORNER

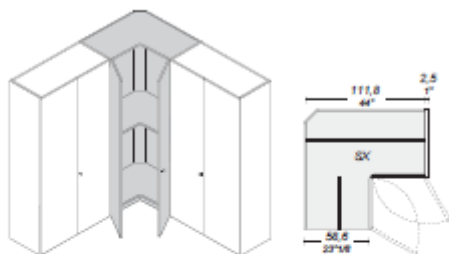

DESCRIPTION

Element designed to obtain angular compositions. The absence of the central upright makes this solution ideal for an easy access inside the corner.

SIZES/ VOLUMES

The external usable width is 118 x 118 cm. In case of combination the total usable width is 113.8 cm (equivalent to the external usable width + 1 side).

H 239/258/290 cm; D 61.7 cm; W 114.8 cm x 114.8 cm.

INTERNAL EQUIPMENT

A shaped shelf, 2 L50.8 cm clothes hanger rail and L118 cm clothes hanger rail.

CAMERINO D'ANGOLO

CORNER CLOSET

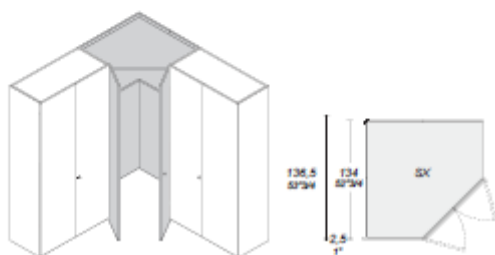

DESCRIPTION

It is designed to carry out angular compositions. The two wing doors open diagonally to the wardrobes and create so a large walk-in compartment without bottom that can be fitting out according to various needs.

SIZES/ VOLUMES

The internal usable width is 128 cm. When positioned between two wardrobes the total usable width is 134 cm. When used only next to one wardrobe the total internal width becomes 137.7 cm.

H 239/258/290 cm. In case of conjunction with sliding door wardrobes the adjacent door must slide internally.

INTERNAL EQUIPMENT

A shaped shelf and 1 clothes hanger rail.

Special elements

ANGOLO SCORREVOLE

SLIDING CORNER

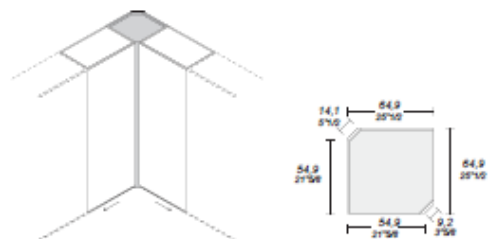

DESCRIPTION

Element designed to obtain angular compositions with sliding wardrobes.

SIZES/ VOLUMES

H 240/260 cm; D 67 cm; W 67 cm

STANDARD EQUIPMENT

A shaped shelf.

N.B. The doors adjacent to the corner of the sliding element must slide on the inner side.

CAMERINO LATERALE

SIDE CLOSET

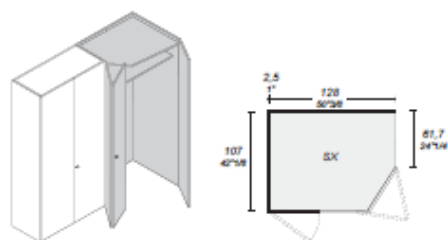

DESCRIPTION

It is designed to assure a large walk-in and fitted compartment, simply by increasing the depth of the end part of a wardrobe.

SIZES/ VOLUMES

The internal usable width is 128 cm. When used next to a wardrobe the total usable width becomes 130.5

cm. When used alone the total usable width is 134.2 cm.

H 239/258 cm; D 107 cm; D 107 with wing door

STANDARD EQUIPMENT

A straight shelf.

MODULO SPAZIO

SPACE MODULE

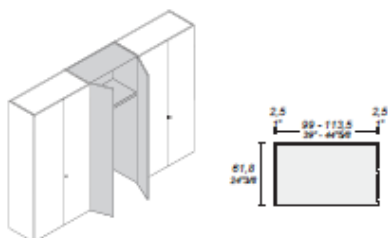

DESCRIPTION

It is designed to assure a different personalization of the wardrobe through the insertion of different fittings.

SIZES/ VOLUMES

The internal usable width is 99 or 113.5 cm. When combined with a wardrobe the external width is 101.5 or 116 cm.

H 239/258/290 cm; D 61.7 cm; W 99/113.5 cm

STANDARD EQUIPMENT

A shelf.

PONTE E PASSAGGIO PORTA

BRIDGE AND DOOR PASSAGE

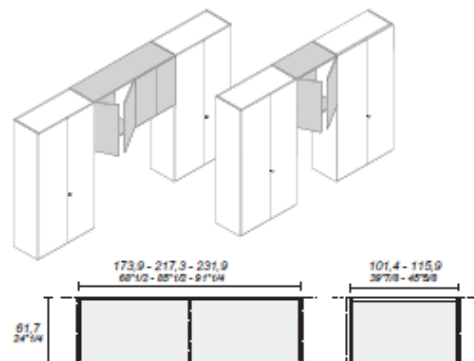

DESCRIPTION

It is the ideal solution for walls with doors or for little bedrooms where the depth dimensions of wardrobe + bed can create problems.

SIZES/ VOLUMES

The bridge and the door-passage are available with H 60.4 cm and H 92.4 cm.

They can be joined to wardrobes H 239/258/290 cm.

D 61.7 cm; W for BRIDGE 173.9 cm/ 217.3 cm/ 231.9 cm; W for DOOR-PASSAGE 101.4 cm/ 130.5 cm

STANDARD EQUIPMENT

Not included.

Customerized wardrobes

CONDIZIONI PER IL MONTAGGIO ASSEMBLING CONDITIONS

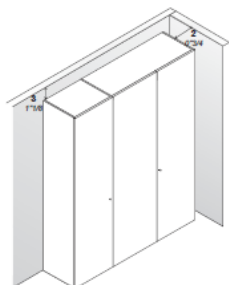

For a correct assembling the wardrobe should be:

- 3 cm lower than the top (or niche) in case of wing opening, or 7 cm lower in other cases
- 2 cm smaller in width than the wall

SISTEMA DI CALCOLO SOVRAPPREZZI COMPUTE RULE OF SURCHARGES FOR REDU

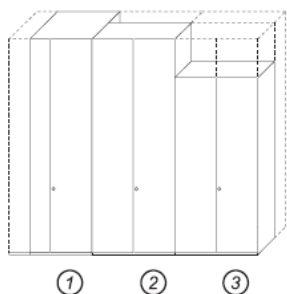

To calculate the cost of reductions it is necessary to verify, for each single module, what dimensions are interested by the reductions and then add the cost to wardrobe price.

Esempio

Example

ARMADIO DI PARTENZA (Anteprima battente)

WARDROBE (Anteprima with wing doors)

Modulo	①	ridotto in larghezza
Module		reduced in width
Modulo	②	ridotto in profondità
Module		reduced in depth
Modulo	③	ridotto in altezza e profondità
Module		reduced in height and depth

ANTE OLTRE LA STRUTTURA DOORS ABOVE THE STRUCTURE

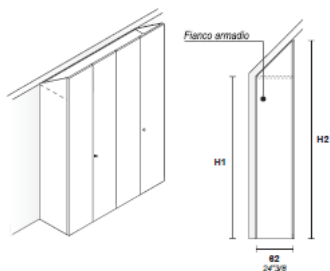

These wardrobes are used for sloping roofs or where there are low beams along the wall.

HOW TO ORDER:

Simply specify the heights:

H1 (lowest point of the roof)

H2 (height at a distance of 62 cm from wall to floor)

The price of the wardrobe is obtained by taking the price of the next size up wardrobe and adding the extra for the height reduction for every modules.

Customerized wardrobes**WARDROBES WITH WING DOORS**

Reductions are possible at a constant pitch of 3.2 cm. For reductions at a different pitch an increase of 50% on the reduced price should be considered.

For depth reductions it is necessary to fix the wardrobe to the wall

WARDROBES WITH SLIDING DOORS

The table below shows the reduction upcharges for each compartment. Height and width reductions for glass doors are not possible.

For depth reductions it is necessary to fix the wardrobe to the wall

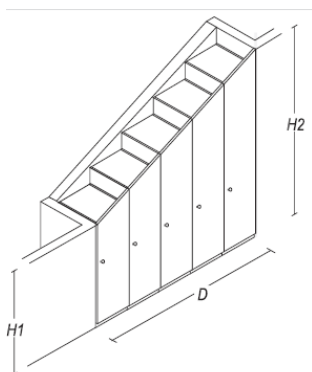
WARDROBES WITH WING DOORS AND DIAGONAL CUT

Diagonal cut is possible only with modules W43.5/ 50.8/ 58.

The table below shows the prices of the diagonal cut for each compartment.

The columns are individual modules (W43.5; W50.8; W58) and the doors are hinged on the longest side. When ordering, please indicate H1 and H2 and the distance D and always send the drawing. The indicated prices must be added to the price of each single standard column in the next up from the one required.

Customerized wardrobes: customized reductions

VERTICAL CLOSING(0 -20 H ARMADIO) max. 300

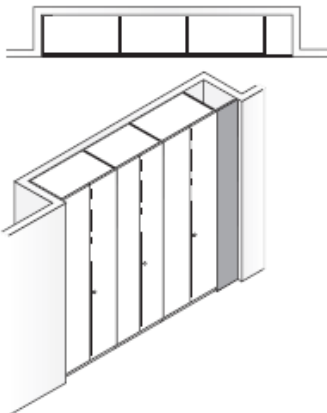

Finishes : Texture – Decor- Lacquered - Thermo treated Oak Veneer - Natural olive or open pore glossy lacquered Ash veneer

HORIZONTAL CLOSING(0-20 L ARMADIO) max. 300

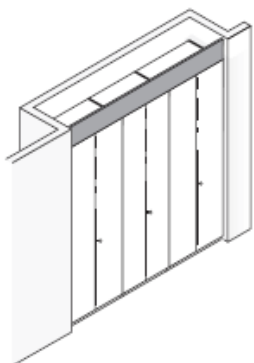

Finishes : Texture – Decor – Lacquered - Thermo treated Oak Veneer - Natural olive or open pore glossy lacquered Ash veneer

SIDE PANEL DOOR

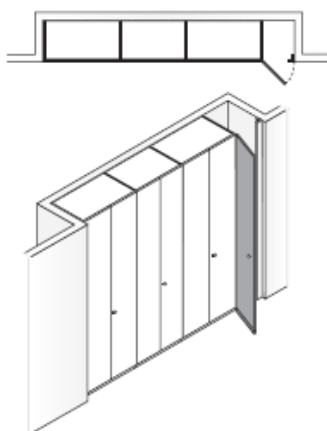

DOORS : H240-260 Anteprema - H292 Anteprema - *The edge of the adjustment door is made of lacquered wood, the handle provided is "Pugh-Open" and the width varies from 10 to 57.5 cm.*

Internal equipments:

- **Unit drawers with 2 or 3 drawers** with a secret drawer optional
- **Filler panels for units drawers**
- **Shelves** in melamine or lacquered snow white, TH. 25 or 38 mm, D. 43 or 55 cm
- **Glazed shelves** TH. 8 mm, D. 43 or 55 cm
- **Shelves** in melamine or lacquered snow white for special elements
- **Pull-out shelves** in melamine or lacquered snow white
- **Pull-out trouser rack Shelves** in melamine or lacquered snow white
- **Carabottini:** open compartments or with drawers that it is possible to fix to sides with baionet system
- **Side panels** H. 93,6 – 128,8 – 164 – 199,2 cm e D. 43 or 55 cm
- **Shoes rack** in comfort ord white varnished metal, W. 41 or 48,3 cm
- **Pull-out tray**
- **Clothes rod**
- **Pull-out clothes rod**
- **Carabottino for unit drawers**
- **Pull-out mirror**
- **Personal compartment**
- **Sanification machine:** *Thanks to the employment of one ions dispenser combined with an anti-germicide lamp, this system deodorizes and sterilizes clothes, shoes or any other object placed to its inside in absolutely innocuous way for the man. It directly takes part on organic particles presents in textile materials, destroying them; in addition it eliminates smells by oxidation of its chemical flown compounds. Its is equipped with a programmable timer.*
- **7 arms trouser rack**
- **Pull-out clothes hanger rail** for fitting to top
- **Clothes hanger pole**
- **Pull-out belt-rack** for sitting to side
- **Pull-out tie-rack** for sitting to side
- **Fixed tie-rack** for sitting to side
- **Ties-rack**
- **Fixed internal mirror**, H. 182 L.31 for doors W. 43 cm and H. 182 W. 42 for doors W.50 cm

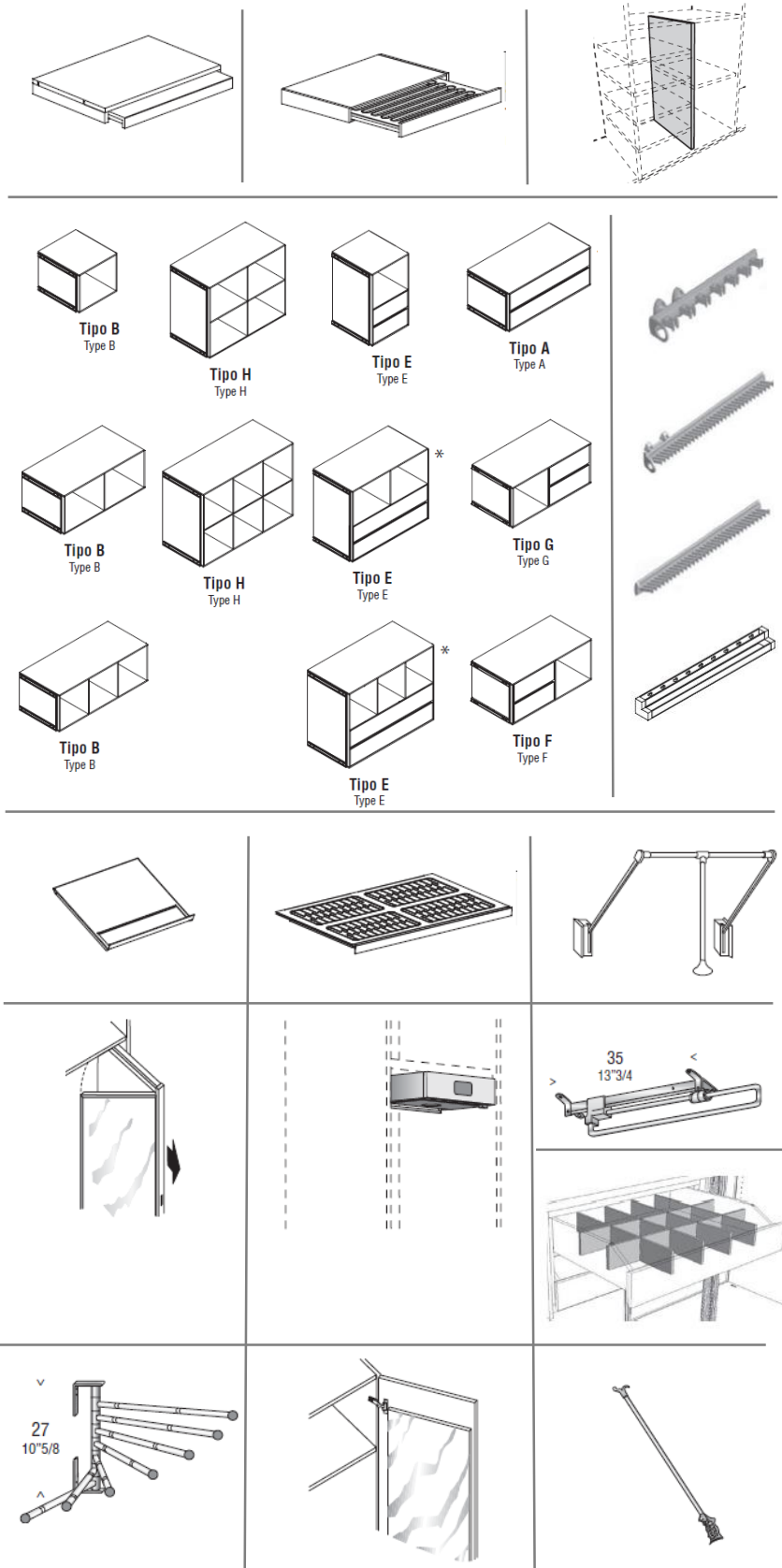

Internal equipments: drawer units

GENERAL CHARACTERISTICS

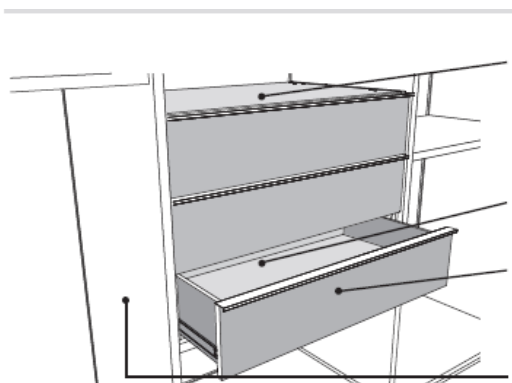

FINISH TOP 0,8 cm thick Texture, Decor or Lacquered finish 1.2 cm thick, or Backlacquered glass 0.8 cm

DRAWER INTERNAL STRUCTURE in Grigio Perla PVC finish.

DRAWER FRONTS in Texture, Decor or Lacquered finish.

STRUCTURE in Texture, Decor or Lacquered finish.

DRAWERS OPENING

In order to guarantee the correct opening of the drawers, please note that according to the type of door assembled, the space will be reduced in such way:

- Wing door, 6 cm for each single compartment; due to the space occupied by the hinges; 12 cm for each double compartment;
- Flush-fit doors, 6 cm, considering that the door doesn't completely open the hollow.
- Sliding doors, 6 cm, in case the handle is on door edge; 12 cm if the handle is on front of the door.

CLOSING DRAWERS

The drawer is equipped with drawer stop which assures a slow and silent closing..

DRAWER UNIT POSITIONING

A) SUPPORTED BY SHELF OR BOTTOM, WITH A CLOSING TOP B) SUPPORTED BY SHELF OR BOTTOM, WITH A CLOSING SHELF

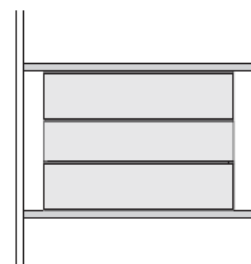
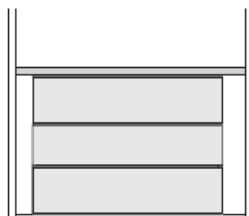
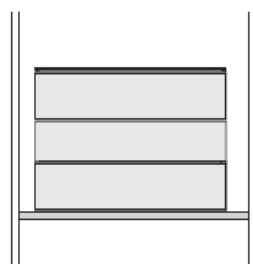
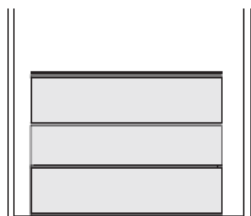

A) SUPPORTED BY BOTTOM, WITH A CLOSING TOP

A) SUPPORTED BY SHELF, WITH A CLOSING TOP

B) SUPPORTED BY BOTTOM, WITH A CLOSING SHELF AND FILLER PANELS

B) BETWEEN TWO SHELVES, WITH FILLER PANELS

Rules for lamps use

On the Riguardaroba's tops and shelves, there can be packed some aluminium lamps with LED illumination, and the switching on is regulated by a sensor. In presence of 6 or more lamps, it is necessary to use 2 power units, since each one has 6 entry.

To feed the lamps use the wired LED driver with max load at least equal to sum of loads of single lamps.

