

# Altagamma

Design by Dario Covi

Family of containers and drawers, with doors and open compartments, all worked at 45°. Some models can be equipped with compartment cable management tube.



## TECHNICAL FEATURES



### External structure /doors and fronts

Made with particle panels and available in finishes: Veneer, Eco-leather Time, Soft Leather.

### Internal structure

Made with particle panels available in finishes: Sablè lacquer, Veneer.

### Handle

Handle of container furniture made of brushed steel. Groove handles are available for the drawers.

### Shelves

Internal shelves made of transparent glass.



Furniture with doors and drawers are available with an entirely Veneer finish (structure, doors, interiors), brushed steel handle and glass shelves.

# DIMENSIONS

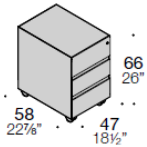

Chest of 3 drawers on wheels

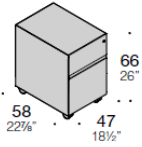

Chest of drawers on wheels with drawer and chest of drawers

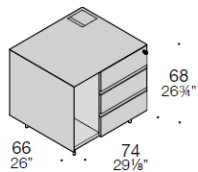

Storage unit W74 (29" 1/8)

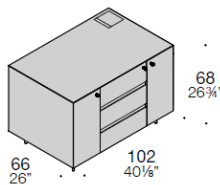

Storage unit W102 (40" 1/8)

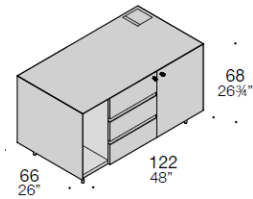

Storage unit W122 (48")

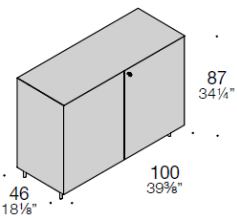

Container W100 (39" 3/8)

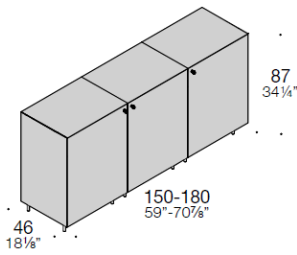

Container W150-180 (59" - 70" 7/8)

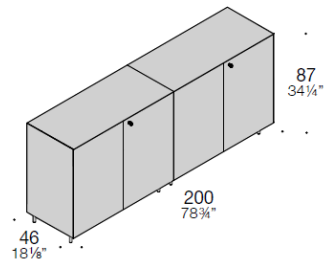

Container W200 (78" 3/4)

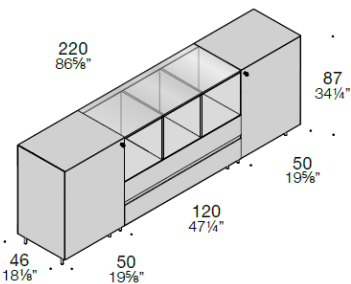

Container W220 (2 W50 modules + 1 W120 module)

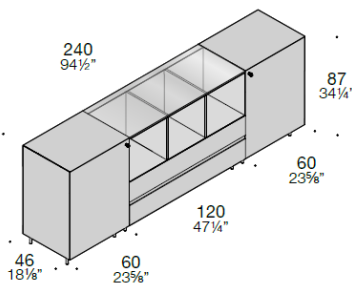

Container W240 (2 W60 modules + 1 W120 module)

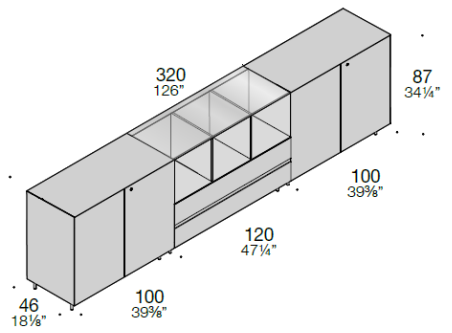

Container L320 (1 W120 module + 2 W100 modules)



Container W320 (126") in Veneer and W102 (40" 1/8) storage unit in leather.



## **HEADQUARTER**

Estel Group srl  
Via Santa Rosa 70  
36016 Thiene (VI) – Italy  
Tel. +39 0445 389611  
Fax +39 0445 808801  
[www.estel.com](http://www.estel.com)

The information shown is based on the latest published price lists. Estel reserves the right to make any necessary changes to the products shown at any time without notice.

**ESTEL rev. 03\_11/2019**

---